

IPC-7132

Cost-effective Wallmount Chassis for ATX/mATX Motherboard and 10-slot Backplane

NEW

PICMG 1.3



Features

- Supports ATX/mATX MB and 10 slot Backplane
- Shock-resistant to hold one 5.25" ODD and three 3.5" HDD
- Supports optional two 2.5" HDD within one 3.5" mobile HDD tray
- Thumb-screw design for top cover opening easily
- Optional PS/2 80 plus bronze 300W/400W power supply
- Bi-directional options to mount chassis on the wall or workbench

CE FCC RoHS COMPLIANT PRODUCT

Specifications

Disk Drive Bay	3.5"	Front-accessible 1	Internal 2
	5.25"	1	-
Cooling	Fan	1 (12 cm/85 CFM)	
	Air Filters	Yes	
Front I/O interface	USB	2	
	Miscellaneous	LED Indicators	Power, HDD
	Control	Power Switch, System Reset Button	
	Rear panel	4x USB, 2x DB-9, 1x LPT port	
Environment	Temperature	Operating 0 ~ 40° C (32 ~ 104° F)	Non-operating -20 ~ 60° C (-4 ~ 140° F)
	Humidity	10 ~ 85 % @ 40° C, non-condensing	
	Vibration (5-500 Hz)	1G	2 G
	Shock	10 G (with 11 ms duration, half sine wave)	
	Physical Characteristics	Dimensions (W x H x D)	200 x 330 x 430 mm (7.9" x 13" x 16.9")
	Weight	9.96 kg (21.93 lb)	

Front view

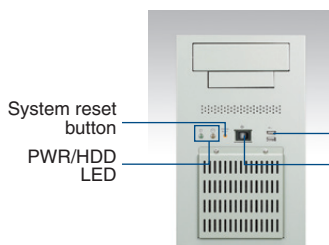

Inside view

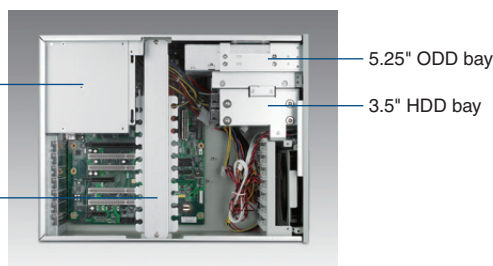

IPC-7132MB

Rear view

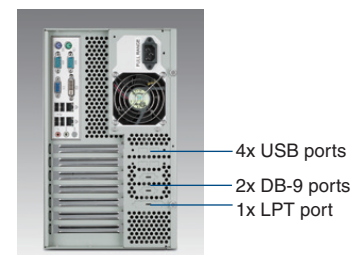

IPC-7132MB



Easy-to-maintain cooling fan

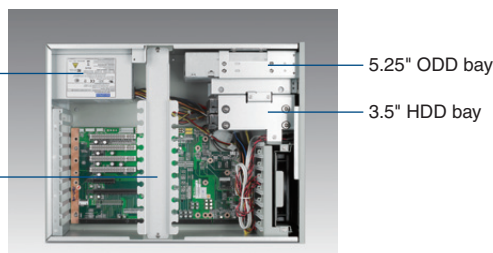

IPC-7132BP

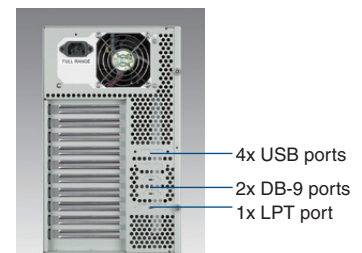

IPC-7132BP

Dimensions

Unit: mm [inch]

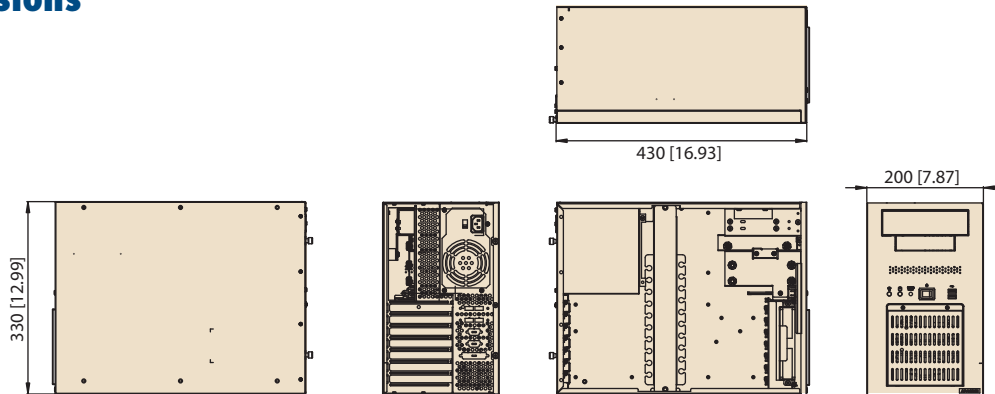

Installation

Unit: mm [inch]

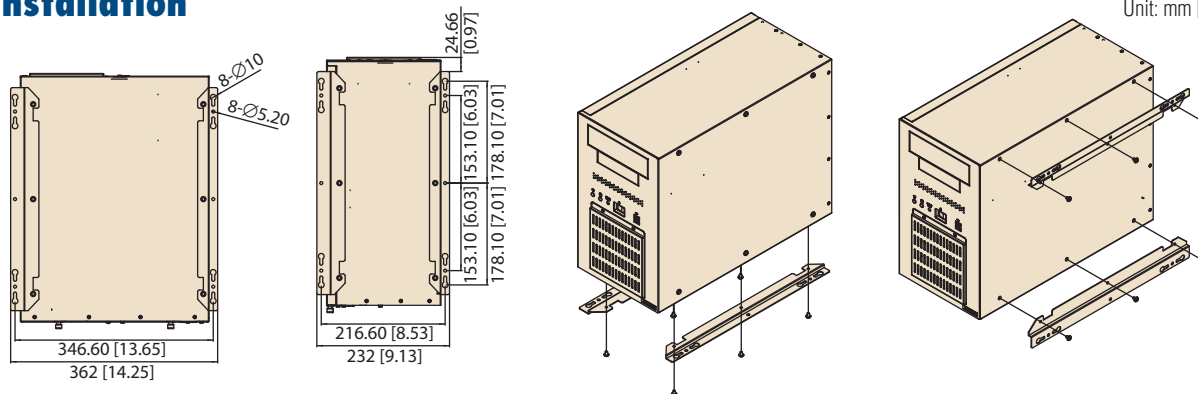

Ordering Information

Model name	Power Supply
Motherboard Version	
IPC-7132MB-00XE	Without power supply, with ATX switch
Backplane Version	
IPC-7132BP-00XE	Without power supply, with ATX switch

Backplane Options

Model	PICMG 1.3	PCIe	PCI-X	PCI
PCE-5B09-06A1E	PICMG 1.3	1 (PCIe x4)	-	6
PCE-5B09-04A1E	PICMG 1.3	3 (PCIe x4)	-	4

Power Supply Options

Part number	Watt	Input
PS8-300ATX-ZBE (ATX,PFC)	300 W	AC 100 ~ 240 V (full range)
PS8-400ATX-ZE (ATX,PFC)	400 W	AC 100 ~ 240 V (full range)

Optional Accessories

Part Number	Description
IDT-3120E	Mobile HDD tray for dual 2.5" SATA HDDs
1750006427	87.87 CFM, system fan 120 x 120 x 25.0 mm
1990001392	Filter cover for IPC-7220 A1